

Deflection & Natural Frequency

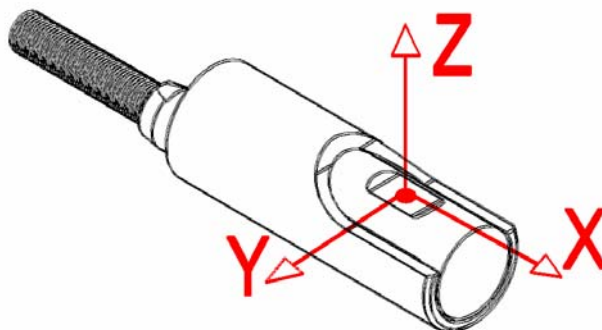

Material	Capacity (lb)	Fz Deflection (in.)	Natural Frequency (Hz)	β
(AL*)	50	0.005	3,300	0.0086

*FN results are based on calculation of deflection & weight scene on Sensor arm.

Natural Frequency & Frequency Response Equation's:

$$\text{Natural Frequency (FN)} = 3.13 \sqrt{\frac{1}{\frac{\beta}{\text{Capacity}} \cdot \text{Deflection}}} \text{ (Hz)}$$

$$\text{Frequency Response with load (FR)} = 3.13 \sqrt{\frac{1}{\frac{\beta + \text{AppliedLoad}}{\text{Capacity}} \cdot \text{Deflection}}} \text{ (Hz)}$$

*Where β values are obtained by Futek Engineers